

## Signal-Stat 900 Series Trouble Shooting Guide

1. If **nothing is working**, please check for the following:
  - Make sure there is a really good ground to the steering column (metal to metal) or run separate ground wire under anchor clip to chassis
  - Re-check the wire colors / locations
  - Check for shorts where wires are spliced
  - Use a (3) terminal flasher; "P" = Pilot (Blue), "L" = Load (Yellow), "X" = Power from battery
2. The **pilot light not working** is usually a good indication of insufficient ground, the flasher is bad or the bulb could have burned out.
3. The **pilot light is staying on** usually means the Blue and Yellow wires are connected together on a two terminal flasher, (see note 8).
4. The **hazard lights flash but the turn signals don't**. Make sure there is a really good ground (metal to metal) contact between the strap and steering column. The quality of 6V flashers is poor. They have small parts that break during shipping. Some customers have to try 2 or 3 of them before they find a good flasher, (see note 1).
5. **Positive ground** vehicles do not affect the switch, installation is the same.
6. If customer has **separate hazard and turn signal flashers**, 2 possible methods:

Method 1 - try hooking up a jumper wire between the 2 flasher power terminals. This terminal is usually marked with "L" adjacent to the terminal. You would also run the YELLOW wire from the turn signal switch to one of the 2 "L" terminals. This is the power for the switch. With this method, you will continue to use BOTH flashers. If you want the green and red indicator lights on the turn signal switch to work, you would also have to run the BLUE wire from the switch to the "P" terminal of BOTH flashers.

Method 2 - is to run the wires from your hood indicators from the hazard flasher to the "P" terminal of the turn signal flasher. With this method, you will only use ONE flasher to do both functions. Again, if you want the green and red indicator lights on the turn signal switch to work, you would also have to run the BLUE wire from the switch to the "P" terminal of the flasher.
7. If customer has a **Painless Wiring Harness** with separate turn and hazard flashers:
  - Disconnect the Painless Flasher
  - Add a jumper wire between the two slots
  - Install a 263 (3) terminal flasher; P = Blue for Pilot or indicator light, L = Yellow for load, X = Purple, wire # 952 from harness for Power
8. If customer only has a **2 terminal flasher** instead of 3 terminals: "L" terminal = Yellow and don't connect the Blue wire. However, the green and red indicator lights on the turn signal switch will not function, (see note 3).
9. Wagner and Tridon flasher terminals are labeled different then stated above:  
B = Battery, L = Load (Yellow), E = Pilot (Blue)





# Installation, Wiring and Operating Instructions for Series 900 Switch

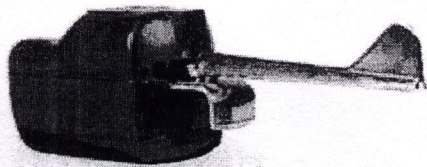

Series 900

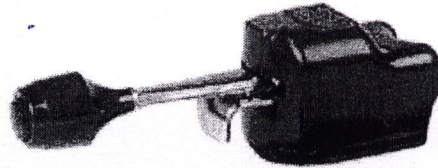

Model 905

FOR NEW INSTALLATIONS & MAJOR CONVERSIONS REQUIRING A FLASHER AND FUSE IN LINE, ORDER SIGNAL-STAT NO. 9186 UNIVERSAL CONNECTOR ASSEMBLY & 3 TERMINAL FLASHER

## How to operate Series 900 Switch

### To Signal Turns:

Move switch handle in direction of turn. Green pilot light will flash to indicate proper functioning. If pilot light does not flash, check for defective lamp or pilot bulbs before checking flasher.

### To Operate Flare:

With switch handle in neutral position, pull flare tab out. All signal lamps & red pilot light will flash for all-around vehicle protection.

### To Release Flare:

Move switch handle left or right. Tab flare will release automatically. Return switch handle to neutral position.

### To Operate Hi/Lo Beams (Model 905 Only):

Push handle button in to activate Hi/Lo beams. RE-push buttons to return to regular headlights.

System Voltage	Lamps To Be Flashed	Signal-Stat Flasher To Be Used
12V	6*	263

\* Exclusive of pilot lights

CAUTION: Power lead must be connected to a line which is hot when ignition switch is off for hazard warning signal to operate when motor is not running!

## How to mount Series 900 Switch

1. Insert screws into anchors.
2. Insert assembled anchor screws into slots in switch. Do not tighten.
3. Bend strap end through and around clip. Engage clip between anchor and switch housing.
4. Hold switch against steering column in desired position and bend strip around column. Scrape paint from column under strap to make a really good ground contact.
5. Estimate strap length required and cut it as necessary. Insert unbent portion of strap through other clip and assemble as in Step 3.
6. Catch clip under anchor and tighten screws equally until switch is affixed firmly to steering column.

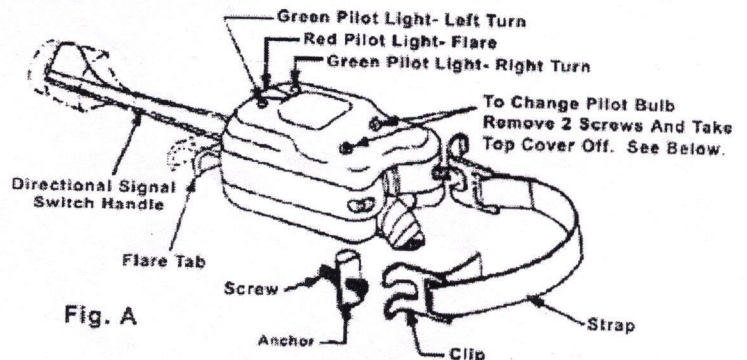

Fig. A

\* When cover is removed, pull Spring Clip away from handle to disengage socket & pilot bulb assembly from handle. Replace pilot bulb with #51 for 6 volt, #53 for 12 volt, or #356 for 24 volt service. Re-engage pilot bulb assembly back into handle. Do not try to test pilot bulb until after switch is reassembled and grounded.

\* Replace flashers as follows: for 12V, 263; for 24V, 263-4.

**Truck-Lite**  
310 E. Elmwood Ave.  
Falconer, NY 14733  
Visit us on the web  
www.truck-lite.com

Customer Service  
(800) 562-5012  
corporate@truck-lite.com

Technical Support  
(888) 562-5012  
titech@truck-lite.com  
Part 30493  
Dwg 46361a1 Pg 1





NOTE: Flasher connector are not included with switches Use 3 Terminal Flasher No. 263 connector assembly when required.

### How to wire Model 900, 901 & 910 switch

1. Mount switch on steering column, making sure to have very good ground (metal to metal) under mounting strap, as shown in Fig. A.
2. Remove flasher during wiring. Replace flasher only after wiring is completed & checked.
3. Wire as indicated in Fig. B.
4. Tape ends of unused wires to prevent shorts.
5. Replace flasher to complete installation.

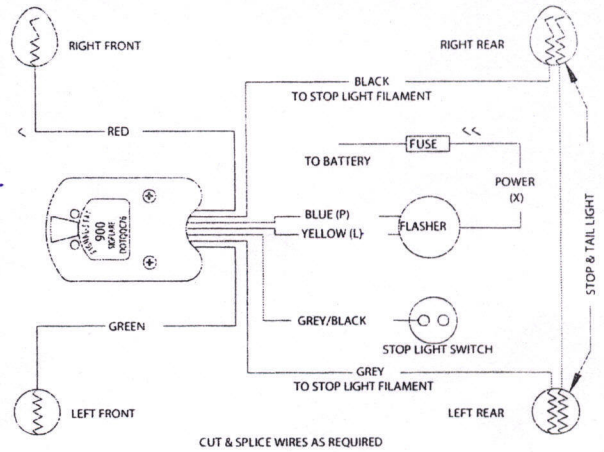

FIG. B

### How to wire Model 902 & 903 switch

1. Mount switch on steering column, making sure to have very good ground (metal to metal) under mounting strap, as shown in Fig. A.
2. Remove flasher from harness during wiring. Replace after wiring has been completed and checked.
3. Wire as indicated in Fig. C.
4. Replace flasher to complete installation.

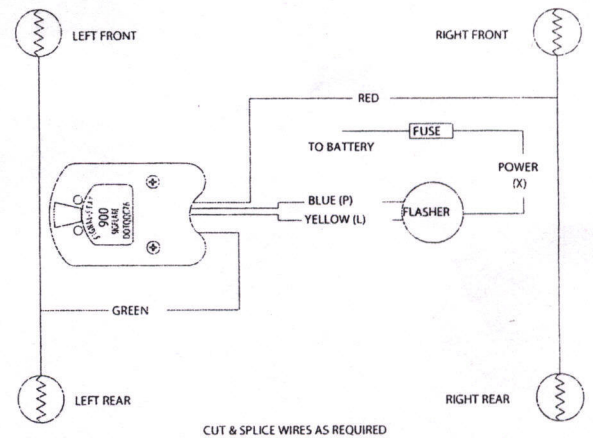

FIG. C

### How to wire Model 905 switch

1. Mount switch on steering column, making sure to have very good ground (metal to metal) under mounting strap, as shown in Fig. A.
2. Wire turn signal & hazard warning functions as indicated for 900 switch in Fig. B, except disregard blue wire. 905 does not have the pilot.
3. Disconnect ground cable from battery.
4. Wire headlight Hi/Lo beam circuit as indicated in Fig. D.
5. Replace ground cable to complete installation.

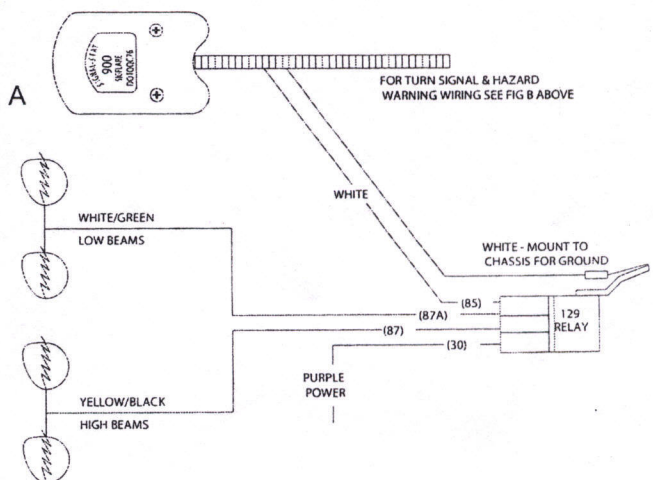
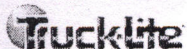

FIG. D

Signal-Stat Series 900 switches are protected by one or more U.S. patent numbers: 2,812,396; 2,886,743; 2,607,840; 2,607,864; 2,652,553; 2,667,603; 2,692,961; 2,825,045.

Serviceman: Give this instruction sheet to the vehicle owner



310 E. Elmwood Ave.  
Falconer, NY 14733  
Visit us on the web  
www.truck-lite.com

Customer Service  
(800) 562-5012  
corporate@truck-lite.com

Technical Support  
(888) 562-5012  
ttech@truck-lite.com

Part 30493  
Dwg 46361a1 Pg 2



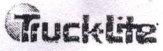

Replacement Parts:

1. Mounting Hardware: 9190
2. Hazard Tab: 9145
3. Handle (900, 901, 902, 903 & 910): 9196
4. Handle (905 Hi-Lo Beam): 9191

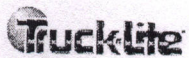

310 E. Elmwood Ave.  
Falconer, NY 14733  
Visit us on the web  
[www.truck-lite.com](http://www.truck-lite.com)

*Customer Service*  
(800) 562-5012  
[corporate@truck-lite.com](mailto:corporate@truck-lite.com)

*Technical Support*  
(888) 562-5012  
[titech@truck-lite.com](mailto:titech@truck-lite.com)

Part 30493  
Dwg 46361a1 Pg 3

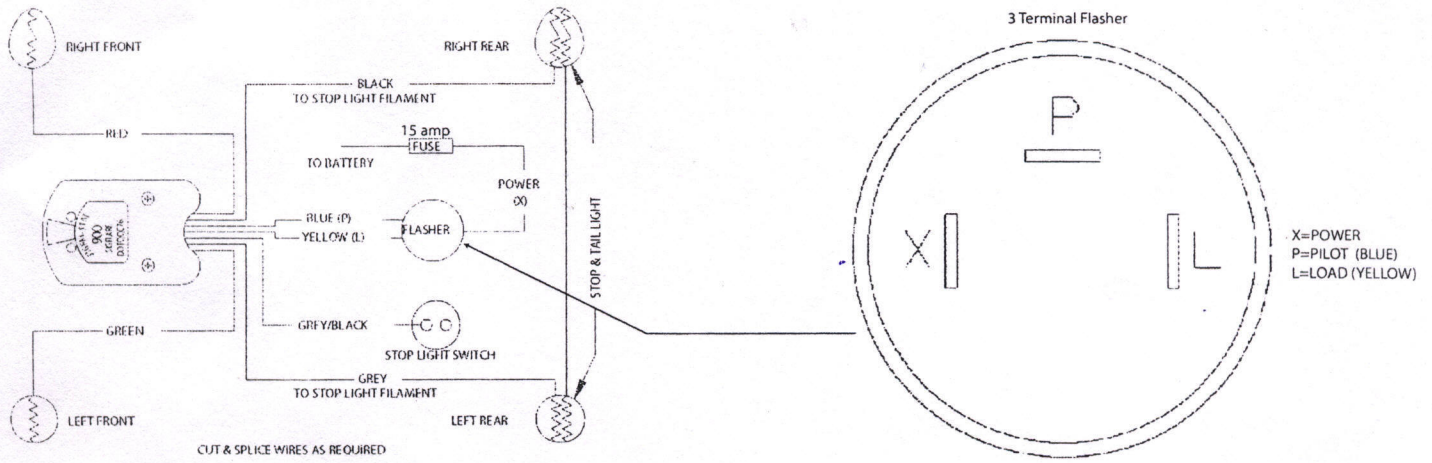

FIG. B

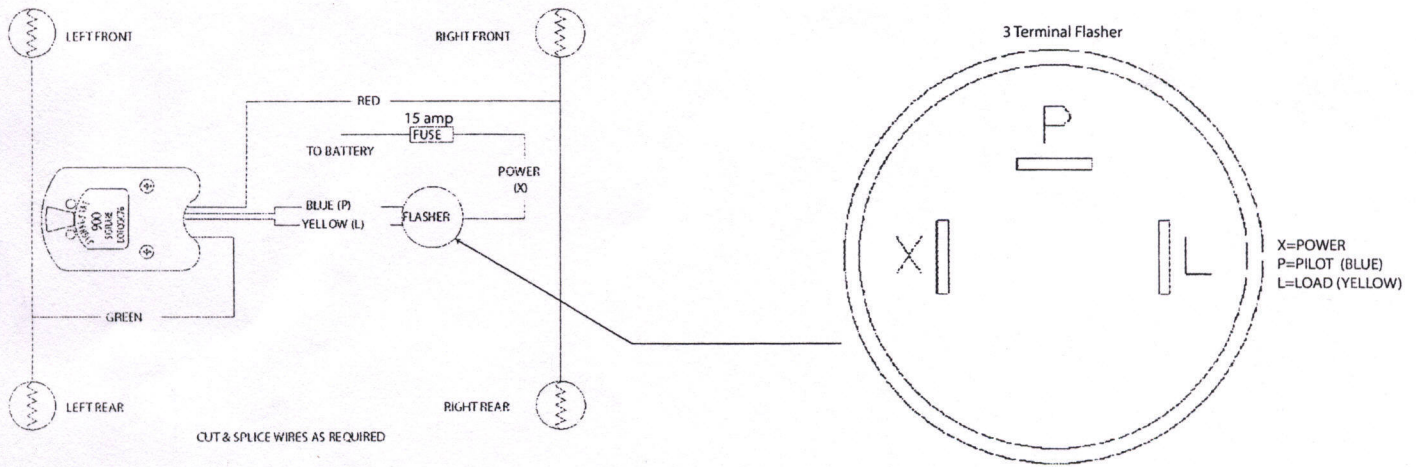

FIG. C

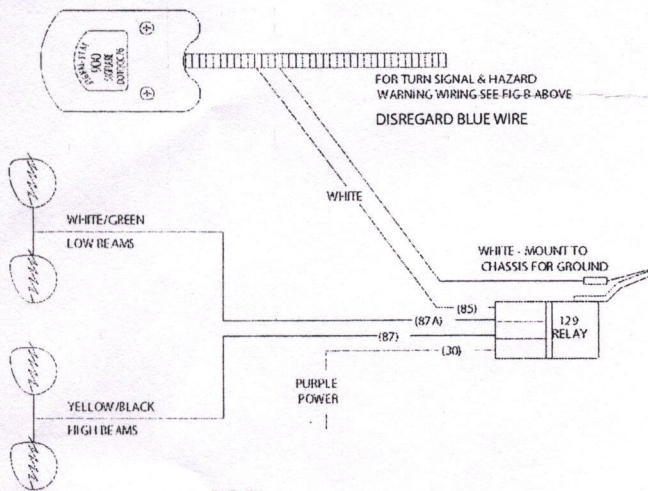

FIG. D